

# Wyr-Grid® Overhead Cable Tray Routing System

Fast...Strong...Simple

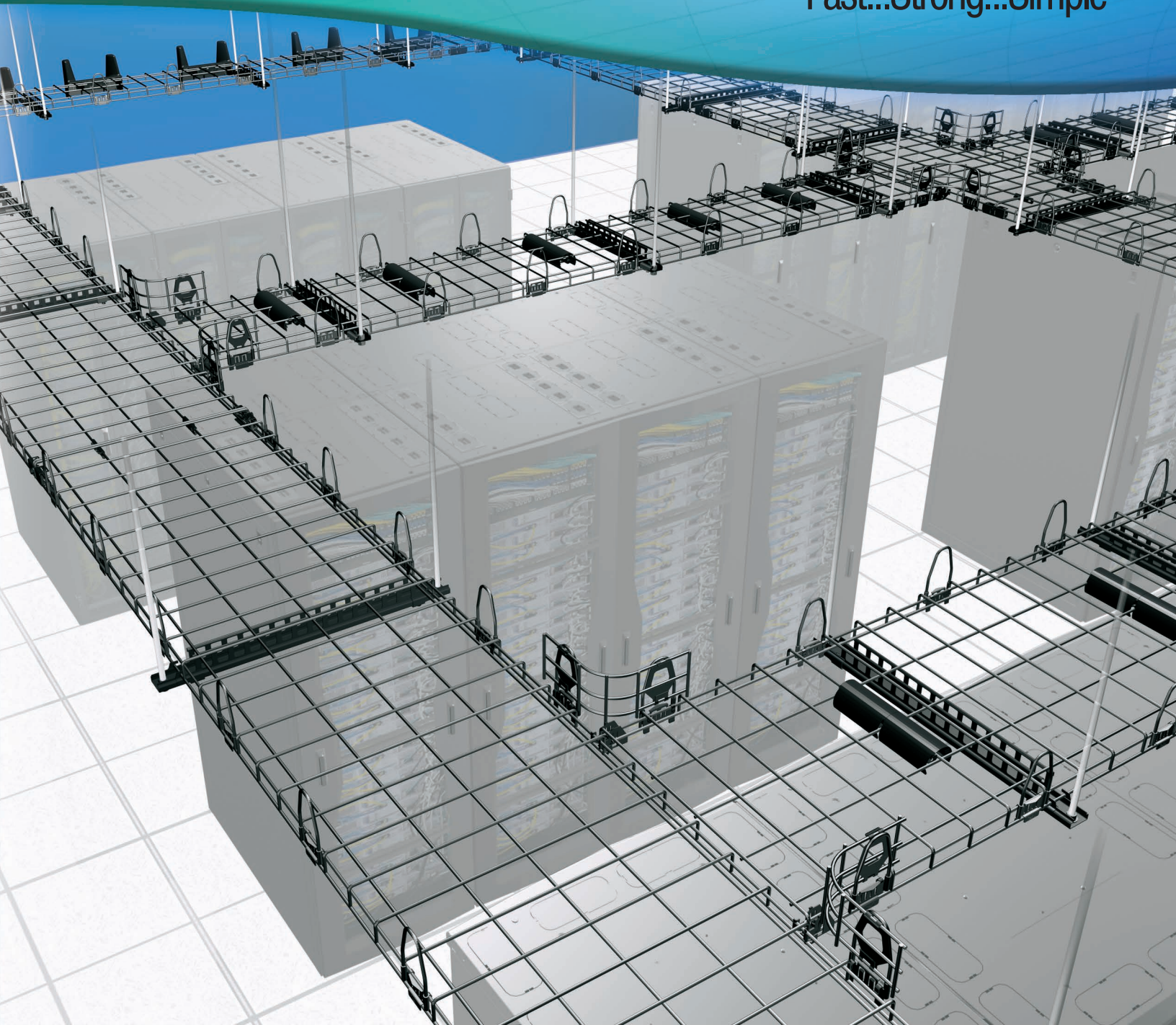

**PANDUIT®**

building a smarter,  
unified business foundation

Connect. Manage. Automate.



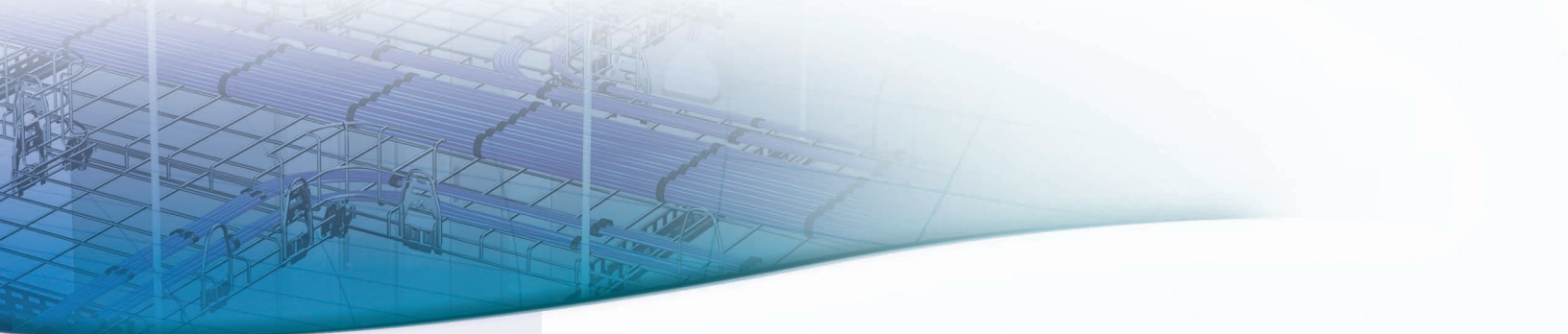

## Panduit's Unified Physical Infrastructure (UPI): a Guiding Approach

A unified approach to physical and logical systems architecture is imperative for solutions to fully address the need for availability, agility, integration, and security.

Panduit has developed the industry's most comprehensive and holistic approach to a Unified Physical Infrastructure and can help enterprises align, converge, and optimize critical systems – communication, computing, control, power, and security – to build a smarter, unified business foundation.

**Mitigate Risk** – Efficient physical infrastructure management enables seamless integration to reduce risks which can occur throughout core systems.

**Lower Cost** – Panduit physical infrastructure solutions drive financial advantages to reduce energy and occupancy costs, and help secure competitive advantage.

**Increase Agility** – A high level of integration within the physical infrastructure enables flexibility and improved business agility.

**Enhance Sustainability** – UPI-based solution offerings enable organizations to meet sustainability goals by driving resource and energy efficiencies across the physical infrastructure.

### Unified Physical Infrastructure



## Reduce Installation Costs, Maximize Cable Protection

Data centers are mission-critical facilities and the nerve center of successful business operations. As more businesses are adopting consolidation, virtualization, and automation of networking assets, a silo-based approach to designing, deploying, and managing the physical infrastructure is becoming increasingly inadequate. With data centers evolving to meet the challenges of complex architectures, new technologies, and increasing performance requirements, a robust physical infrastructure is needed to provide operational benefits to drive business results.

Cable management is a key consideration of the physical infrastructure for optimizing system reliability, effective space utilization, and scalability. Panduit offers industry-leading Cable Routing Systems as part of comprehensive, integrated Data Center Solutions to effectively manage and protect high-performance communication, computing, and power cables. Panduit's Wyr-Grid® Overhead Cable Tray Routing System contributes to effective real estate usage and network performance. It provides speed of deployment, structural integrity, cable protection, and ease of use.

### Quick to Install

In today's fast paced environment, every project is on a tight schedule and needs to be completed NOW. So, it is important that infrastructure components can be installed quickly and with as little delay as possible. That is where the Panduit Wyr-Grid® Overhead Cable Tray Routing System provides a true advantage. It is designed and engineered to assemble in significantly less time than other wire basket and ladder rack systems. It will save you valuable time.

### Robust Construction and Support

In today's typical build out, every project needs a secure platform that can support and protect the cabling infrastructure. So, it is important that the cable routing pathways are strong enough to support the cable loads that will be encountered today and in the future. The Panduit® Wyr-Grid® Overhead Cable Tray Routing System has been designed and tested to comply with industry standards to provide the necessary load bearing strength. In addition, Wyr-Grid® Pathways offer a greater strength to weight ratio compared to other wire basket systems. This advantage will provide you with a robust cable support structure.

### Easy to Work With

Every project has complications and issues that unexpectedly arise, and need to be resolved. It is important that the infrastructure components do not add to this confusion via large part number lists and difficult to understand assemblies. This is another advantage of the Panduit® Wyr-Grid® Overhead Cable Tray Routing System. A focused product offering with minimal components, along with design tools, allows specifiers to quickly understand and identify the necessary parts, and create accurate bills of materials. It will simplify your project.

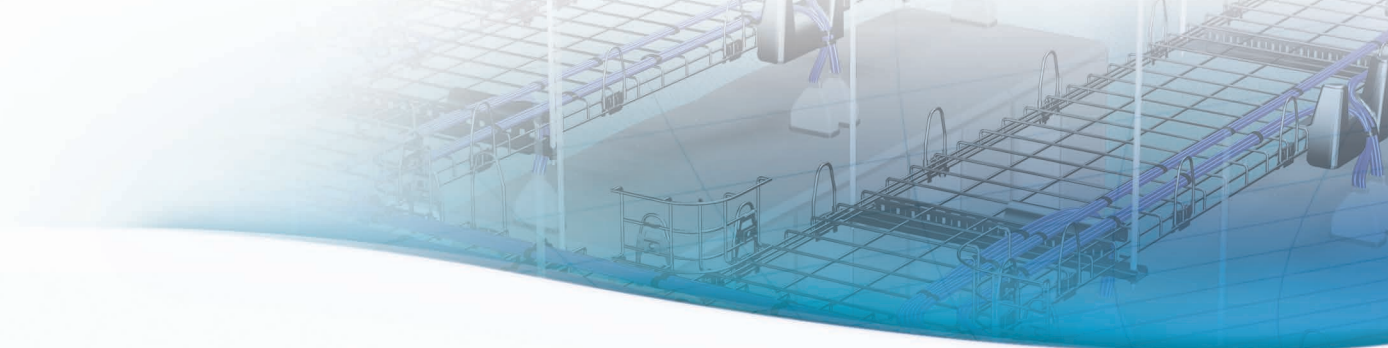

## Fast

The Wyr-Grid® Overhead Cable Tray Routing System has been proven to reduce labor costs by 50% when benchmarked against existing wire basket and ladder rack systems.

Installation Time

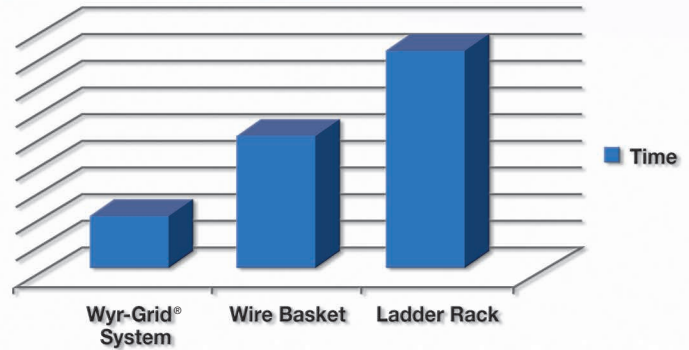

## Strong

The Wyr-Grid® Overhead Cable Tray Routing System has been validated through both analytical and physical testing to meet industry standards for allowable deflection.

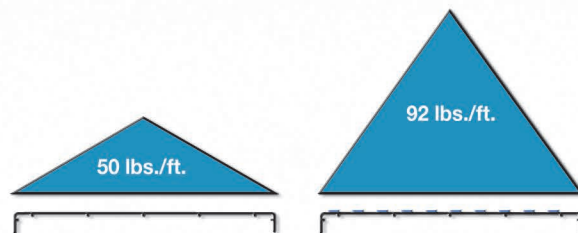

In a high density application a fully loaded 24" wide Wyr-Grid® Pathway will need to support 50 lbs./ft. of cable.

The 24" wide Wyr-Grid® Pathway was tested to 92 lbs./ft. with less than .600" of deflection per IEC 61537. (See page 14 for further information.)

The Wyr-Grid® System has been tested to ensure that it will support cable loads in excess of typical applications.

## Simple

The Wyr-Grid® Overhead Cable Tray Routing System reduces the number of individual components and labor required to create common connections. Fewer components and less labor equal a simpler installation.

Tee Intersection with Bend Radius and Sidewalls

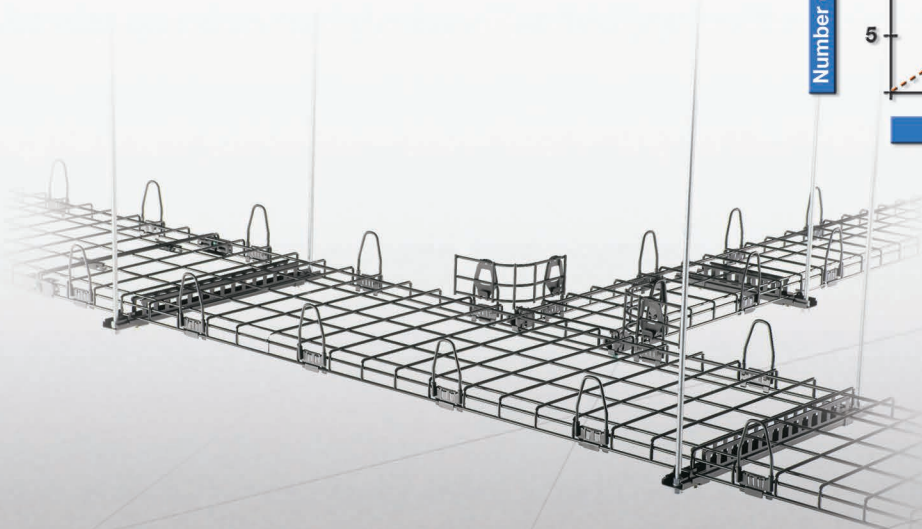
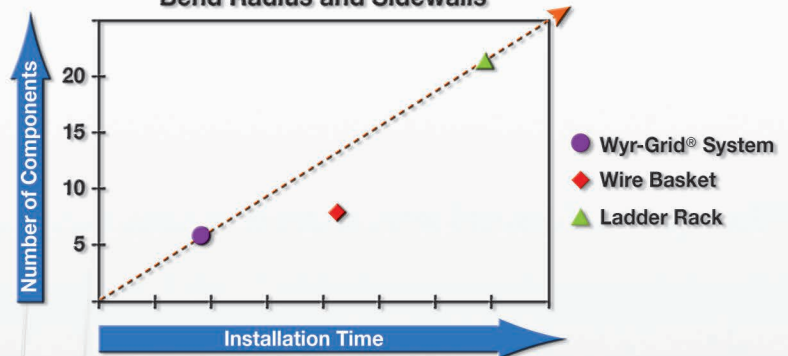



# Typical Wyr-Grid® Overhead Cable Tray System Data Center Application

The Wyr-Grid® System is configured to route and protect cabling between the Main Distribution Area (MDA) or Horizontal Distribution Area (HDA) and the Equipment Distribution Areas (EDA). Key product features significantly reduce installation time, enhance cable management and improve user safety. Because the pathway has no integral sidewalls, the need to cut the sidewalls at intersections, waterfalls, fabricated directional changes, and straight sections is eliminated. Intersection bend radius control accessories install with no hardware or tools and provide a three inch bend radius guide. Splice connectors provide integral bonding, improving user safety. As shown below, these features allow copper data cables to be effectively routed throughout the data center. In applications where power cables are also routed overhead, another level of Wyr-Grid® Pathway can be added to manage these cables. In addition, premise distribution fiber cables can also be routed on a separate level of the Wyr-Grid® System.

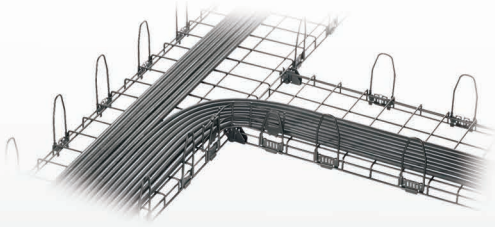

Power cables shown routed on a separate level of Wyr-Grid® Pathway.

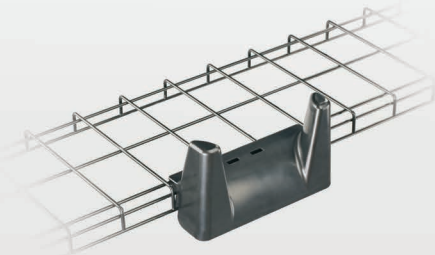

Waterfalls require no cutting or hardware for installation.

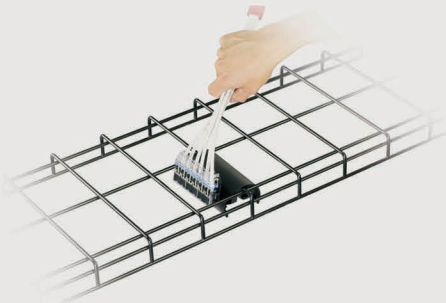

Panduit® QuickNet™ Cassettes pass through Wyr-Grid® openings eliminating the need to cut the pathway.



Route redundant ("A" and "B") cabling into adjacent cabinets with a single waterfall.

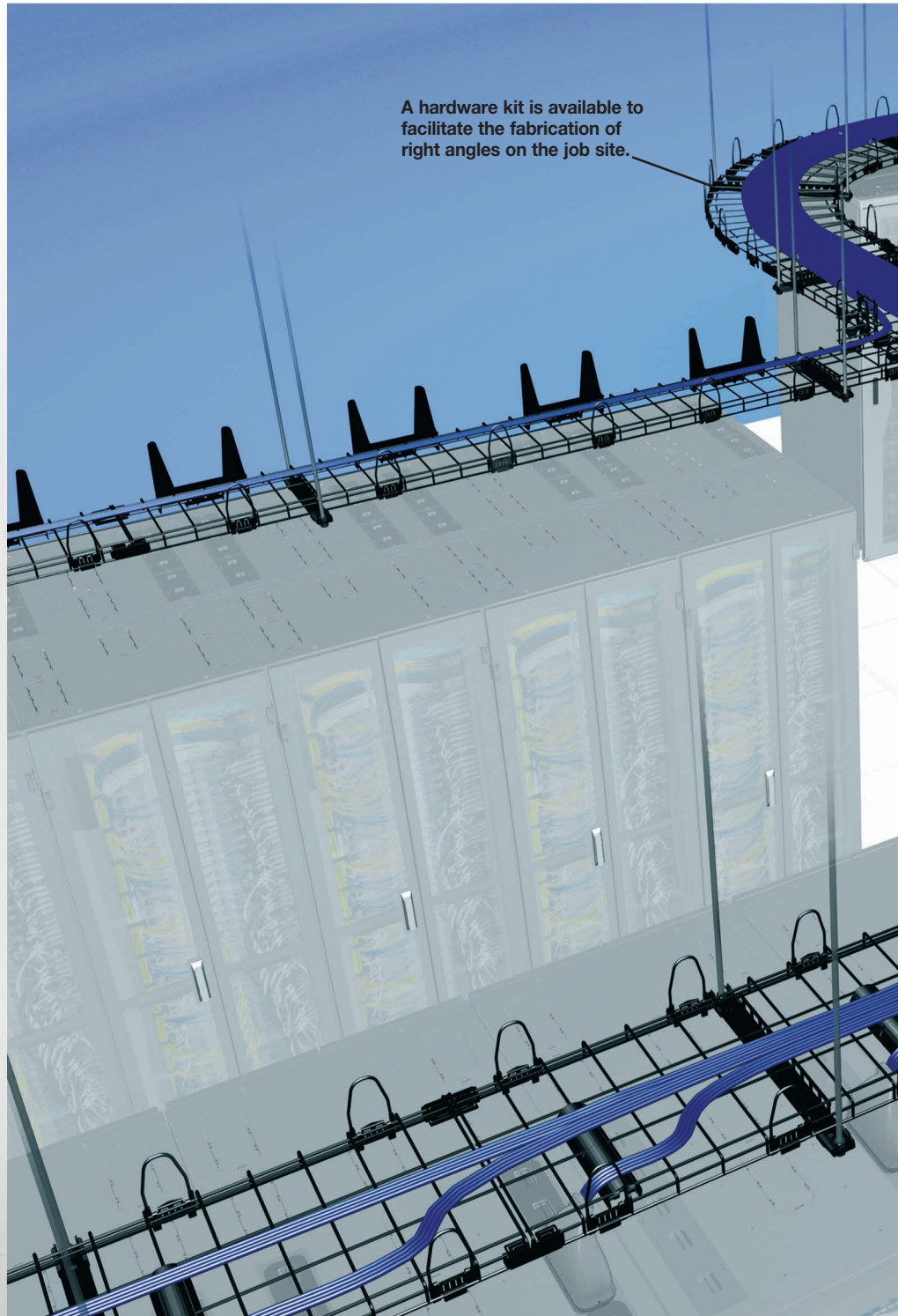

A hardware kit is available to facilitate the fabrication of right angles on the job site.





**Wyr-Grid® Splice Connectors** install by hand, without the use of special tools, unlike other systems.



**Wyr-Grid® Pathways** are easily bonded by simply tightening down the integral screw, unlike other systems that require loose hardware.

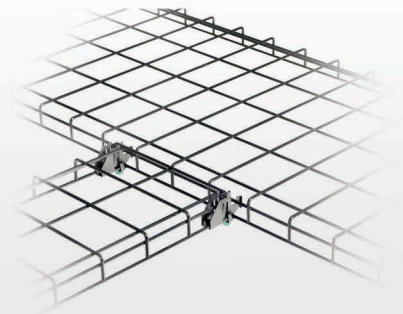
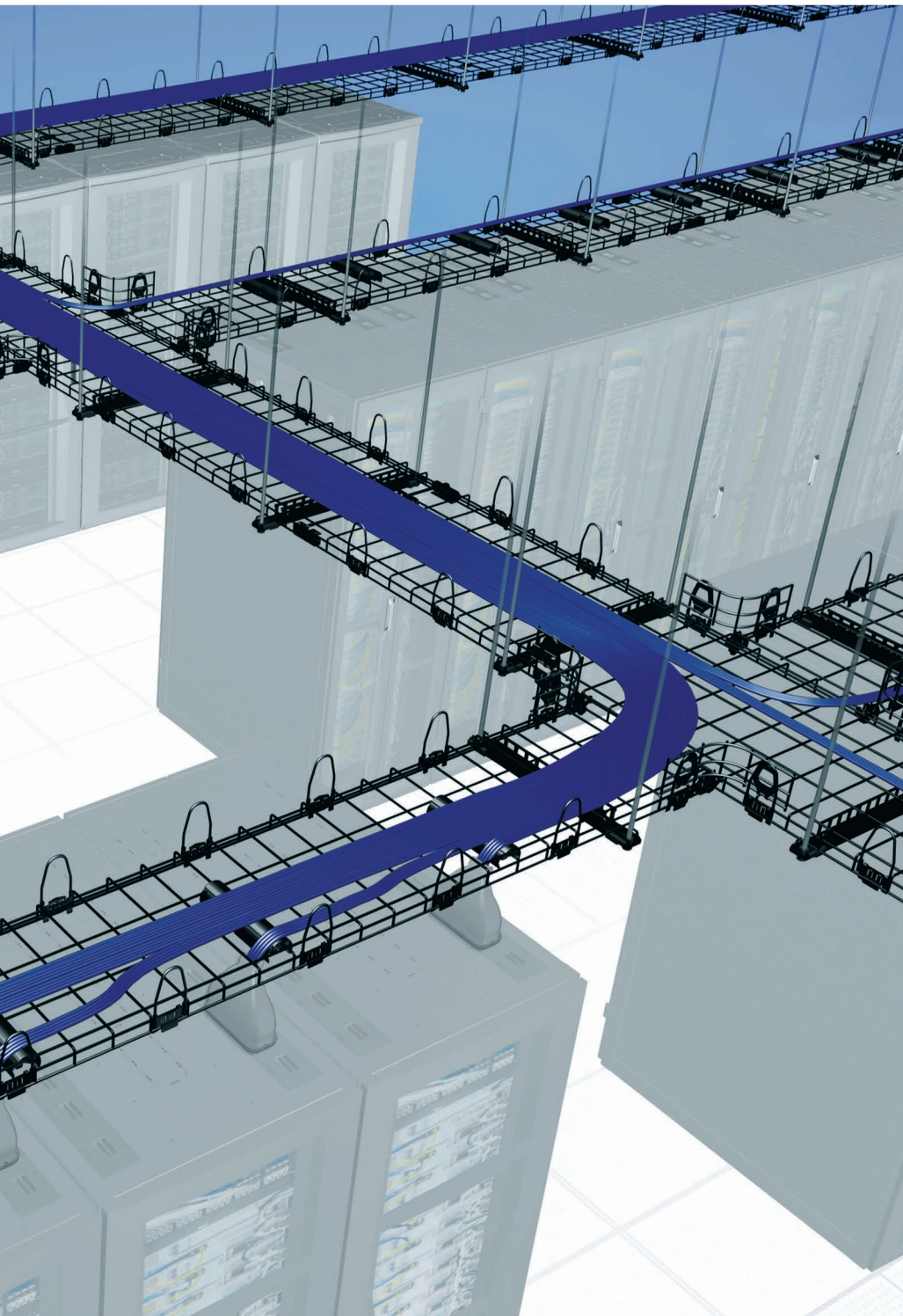

**No sidewall cutting at intersections.**

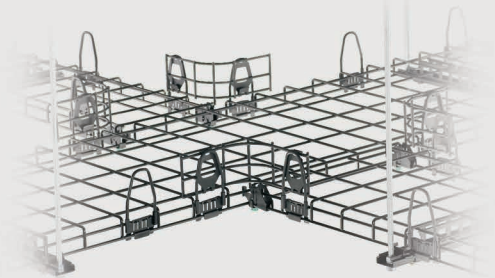

**Intersection bend radius control** requires no tools, cutting, or hardware.

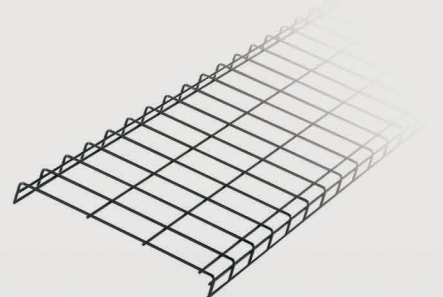

**When cutting is called for, there are fewer wires to cut.**



# Typical Wyr-Grid® Overhead Cable Tray System and FiberRunner® Cable Routing System Data Center Application

The cable routing systems are configured to route and protect cabling between the Main Distribution Area (MDA) or Horizontal Distribution Area (HDA) and the Equipment Distribution Area (EDA). This complete overhead pathway solution enables both copper and fiber cables to be effectively routed within the data center. As shown below, copper data cables are routed along the Wyr-Grid® Pathway and small diameter fiber interconnect cables/patch cords are routed through the FiberRunner® Pathway. In the event that routing power cables overhead is also required, another level of the Wyr-Grid® System can be added above the FiberRunner® System.

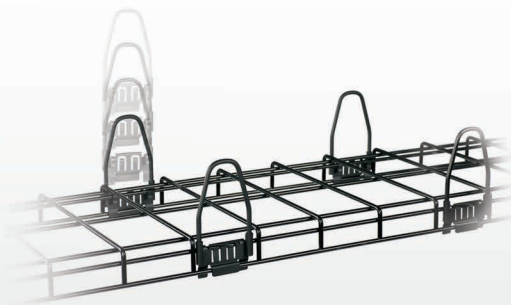

Optional snap-on sidewalls require no hardware or tools for installation. The sidewalls are available in three heights: 2" (50mm), 4" (102mm), and 6" (152mm).



Increase pathway capacity as your network grows by using taller sidewalls. There is no need to install an entirely new pathway.

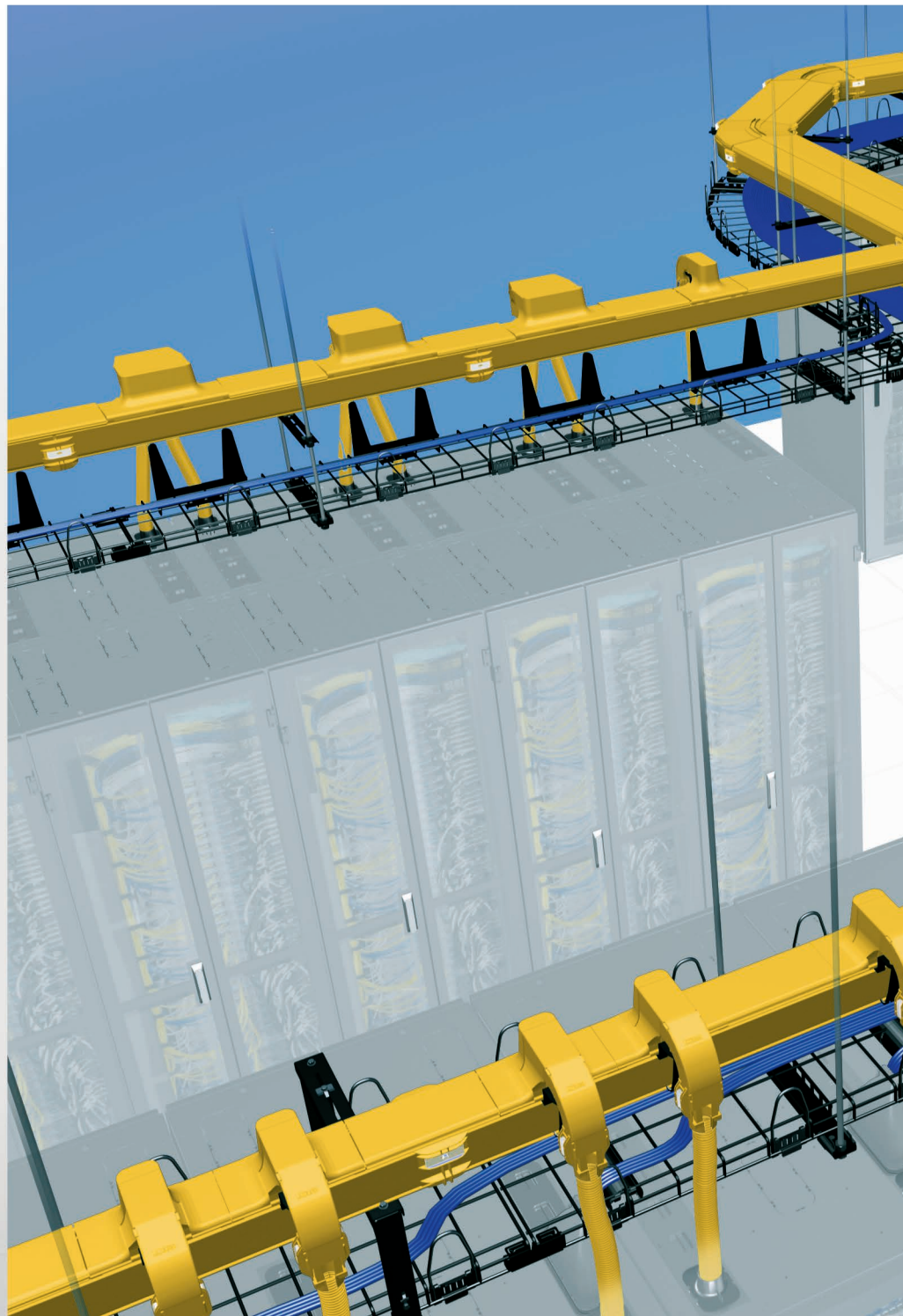
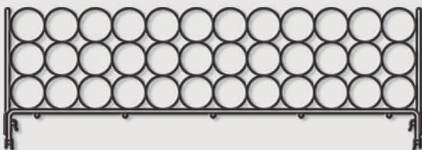





Trapeze brackets are supplied with integral slide clips for securing the pathway in place, eliminating loose hardware. In addition, trapeze bracket design allows side to side pathway positioning increasing installation adjustability.

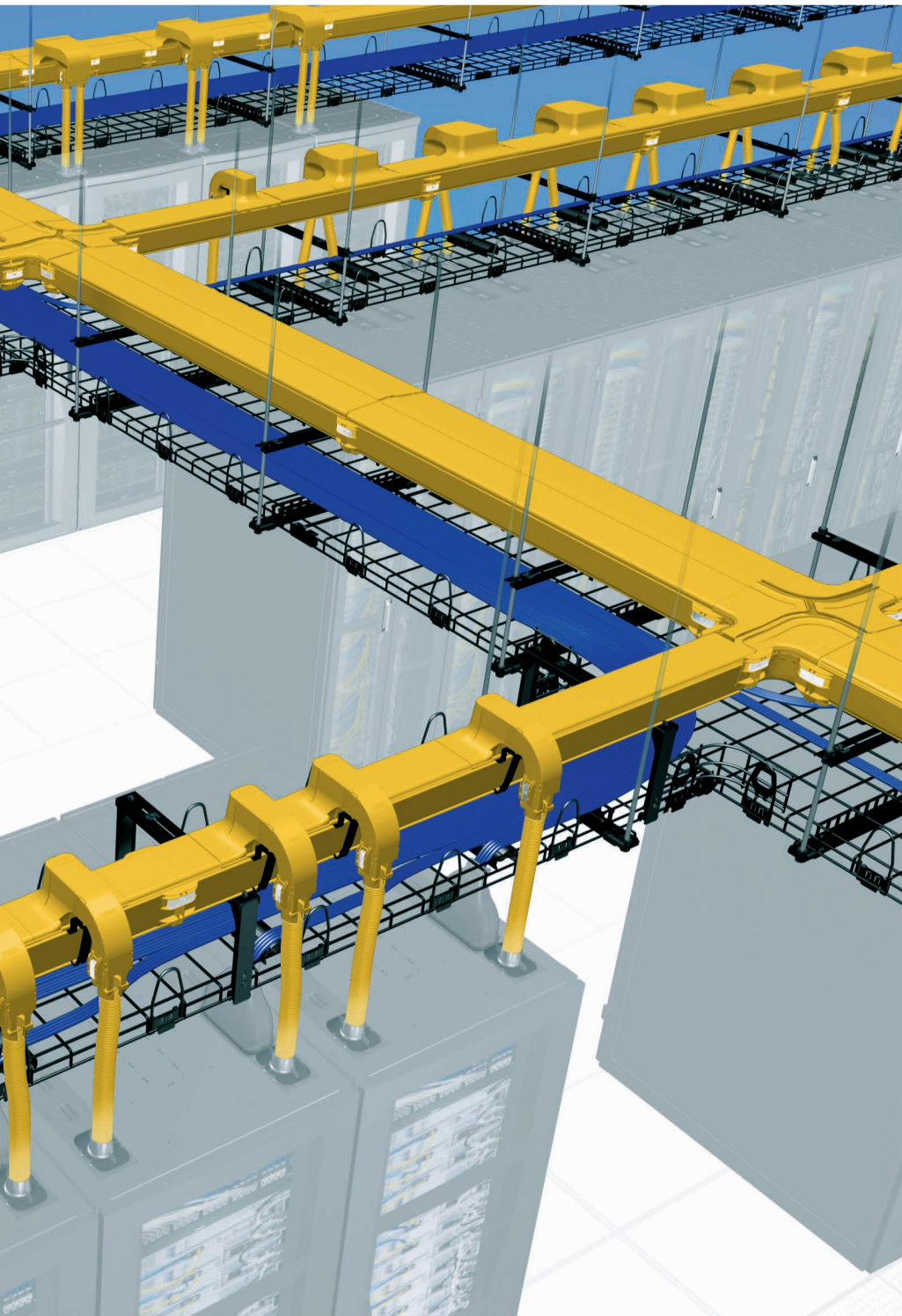
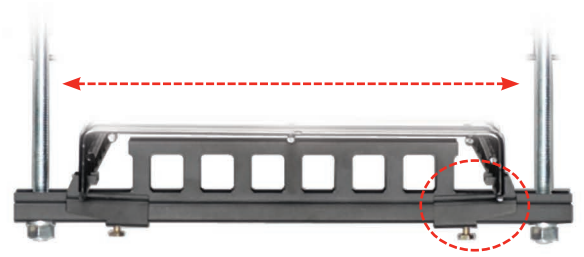

### Seamless Integration of Wyr-Grid® and FiberRunner® Systems



Brackets allow FiberRunner® 4x4, 6x4, 12x4, and 24x4 Pathways to be supported at any height above or below the Wyr-Grid® System. This installation utilizes the same threaded rod to support both systems.



Brackets allow FiberRunner® 4x4 and 6x4 Pathways to be supported at a fixed height above the Wyr-Grid® System. This minimizes the need for additional threaded rod to support the fiber pathway.

## Wyr-Grid® Overhead Cable Tray Routing System

### Wyr-Grid® Pathways

- Pathways are provided in five widths: 8" (203mm), 12" (305mm), 18" (457mm), 24" (610mm), and 30" (762mm)
- Standard finishes are black powder coat and electro zinc plated
- Non-integral sidewalls minimize specification requirements



WG8BL10

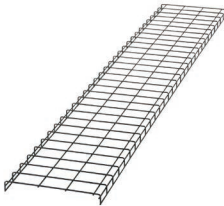

WG12BL10

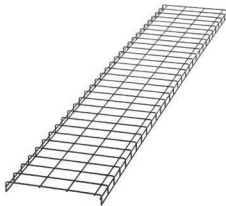

WG18BL10

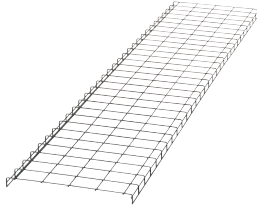

WG24BL10

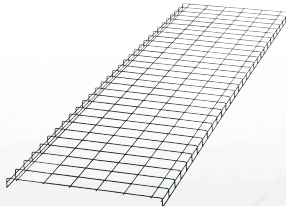

WG30BL10

Part Number	Part Description	Std. Pkg. Qty.
WG8BL10	8" wide x 10' long pathway section used to carry cables horizontally throughout the system. Snap-on sidewalls attach for job specific height requirements. Uses splice connector WGSPL1218BL to connect straight sections and intersection splice WGINTSPLBL to connect pathways at an intersection.	10
WG12BL10	12" wide x 10' long pathway section used to carry cables horizontally throughout the system. Snap-on sidewalls attach for job specific height requirements. Uses splice connector WGSPL1218BL to connect straight sections and intersection splice WGINTSPLBL to connect pathways at an intersection.	10
WG18BL10	18" wide x 10' long pathway section used to carry cables horizontally throughout the system. Snap-on sidewalls attach for job specific height requirements. Uses splice connector WGSPL1218BL to connect straight sections and intersection splice WGINTSPLBL to connect pathways at an intersection.	10
WG24BL10	24" wide x 10' long pathway section used to carry cables horizontally throughout the system. Snap-on sidewalls attach for job specific height requirements. Uses splice connector WGSPL2430BL to connect straight sections and intersection splice WGINTSPLBL to connect pathways at an intersection.	10
WG30BL10	30" wide x 10' long pathway section used to carry cables horizontally throughout the system. Snap-on sidewalls attach for job specific height requirements. Uses splice connector WGSPL2430BL to connect straight sections and intersection splice WGINTSPLBL to connect pathways at an intersection.	10

Order number of feet required, in multiples of standard 10' length increments.  
For electro zinc finish replace BL (Black) with EZ.



## Wyr-Grid® Splice Connectors

- Integral bonding screw creates a mechanical electrical bond between cable tray pathway sections
- Standard finishes are black powder coat and electro zinc plated



WGSPL1218BL



WGSPL2430BL



WGINTSPLBL

Part Number	Part Description	Std. Pkg. Qty.	Std. Ctn. Qty.
WGSPL1218BL	Straight splice connector quickly joins two 8" (203mm), 12" (305mm), or 18" (457mm) wide Wyr-Grid® Pathways together. A thread cutting screw pierces the paint of adjacent pathway sections providing a completely bonded connection, ensuring electrical continuity between the pathways. Package contains two components needed to join two pathway sections.	1	10
WGSPL2430BL	Straight splice connector quickly joins two 24" (610mm) or 30" (762mm) wide Wyr-Grid® Pathways together. A thread cutting screw pierces the paint of adjacent pathway sections providing a completely bonded connection, ensuring electrical continuity between the pathways. Package contains four components needed to join two pathway sections.	1	10
WGINTSPLBL	Intersection splice connector quickly joins Wyr-Grid® Pathways at all intersections. A thread cutting screw pierces the paint of perpendicular pathway sections providing a completely bonded connection, ensuring electrical continuity between the pathways. Package contains two components needed to create one tee or right angle intersection.	1	10

For electro zinc finish replace BL (Black) with EZ.

## Wyr-Grid® Waterfalls

- Offered in two different configurations that attach to all pathway sections 8" (203mm), 12" (305mm), 18" (457mm), 24" (610mm), and 30" (762mm)
- Standard finishes are black powder coat and electro zinc plated



WGBTMWFBL



WGSWF4BL

Part Number	Part Description	Std. Pkg. Qty.	Std. Ctn. Qty.
WGBTMWFBL	The bottom waterfall provides 1.38" (35mm) bend radius control for cables transitioning down into the racks or cabinets from within the Wyr-Grid® Pathway. The waterfalls can be installed side-by-side increasing the overall width of the waterfall.	1	10
WGSWF4BL	The side waterfall provides 3" (76mm) bend radius control for cables transitioning down into the racks or cabinets from the side of the Wyr-Grid® Pathway. Cable retaining posts ensure bend radius control as cables traverse from the horizontal into the vertical path. Plastic design only offered in black color.	1	—

For electro zinc finish replace BL (Black) with EZ.

## Wyr-Grid® Support Brackets

- Offered in various widths to accommodate pathways:  
8" (203mm), 12" (305mm), 18" (457mm), 24" (610mm)  
and 30" (762mm)
- Standard finishes are black powder coat and electro zinc plated
- Integral quick-clip retention
- Accommodates 1/2" or 12 mm threaded rod



WGTBS8BL



WGTBS12BL



WGTBS18BL



WGTBS24BL



WGTBS30BL



WGCB12BL



WGCB18BL



WGCB24BL



WGWMTB8BL



WGWMTB12BL



WGWMTB1830BL

Part Number	Part Description	Std. Pkg. Qty.	Std. Ctn. Qty.
<b>Wyr-Grid® Trapeze Brackets</b>			
WGTBS8BL	Used to support 8" (203mm) wide Wyr-Grid® Pathway from the ceiling using a pair of 1/2" or 12mm threaded rod drops. Hardware for attaching to threaded rod sold separately (see page 13).	1	5
WGTBS12BL	Used to support 12" (305mm) wide Wyr-Grid® Pathway from the ceiling using a pair of 1/2" or 12mm threaded rod drops. Hardware for attaching to threaded rod sold separately (see page 13).	1	5
WGTBS18BL	Used to support 18" (457mm) wide Wyr-Grid® Pathway from the ceiling using a pair of 1/2" or 12mm threaded rod drops. Hardware for attaching to threaded rod sold separately (see page 13).	1	5
WGTBS24BL	Used to support 24" (610mm) wide Wyr-Grid® Pathway from the ceiling using a pair of 1/2" or 12mm threaded rod drops. Hardware for attaching to threaded rod sold separately (see page 13).	1	5
WGTBS30BL	Used to support 30" (762mm) wide Wyr-Grid® Pathway from the ceiling using a pair of 1/2" or 12mm threaded rod drops. Hardware for attaching to threaded rod sold separately (see page 13).	1	5

### Wyr-Grid® Cantilever Brackets

WGCB12BL	Used to support the 12" (305mm) wide Wyr-Grid® Pathway along a wall. Integral retaining clip secures the pathway to the bracket. Mounting hardware for attaching to wall not included.	1	5
WGCB18BL	Used to support the 18" (457mm) wide Wyr-Grid® Pathway along a wall. Integral retaining clip secures the pathway to the bracket. Mounting hardware for attaching to wall not included.	1	5
WGCB24BL	Used to support the 24" (610mm) wide Wyr-Grid® Pathway along a wall. Integral retaining clip secures the pathway to the bracket. Mounting hardware for attaching to wall not included.	1	5

### Wyr-Grid® Wall Mount Termination Brackets

WGWMTB8BL	Used to support the end of the 8" (203mm) Wyr-Grid® Pathway against the wall. Mounting hardware for attaching to wall not included.	1	5
WGWMTB12BL	Used to support the end of the 12" (305mm) Wyr-Grid® Pathway against the wall. Mounting hardware for attaching to wall not included.	1	5
WGWMTB1830BL	Used to support the end of the 18" (457mm), 24" (610mm), or 30" (762mm) Wyr-Grid® Pathway against the wall. Mounting hardware for attaching to wall not included. Package contains two components needed to support the wider pathway sections.	1	5

For electro zinc finish replace BL (Black) with EZ.



## Wyr-Grid® Support Brackets (continued)



Part Number	Part Description	Std. Pkg. Qty.	Std. Ctn. Qty.
<b>Wyr-Grid® Mounting Brackets for FiberRunner® System</b>			
FRTBWG12BL	FiberRunner® QuikLock™ Threaded Rod Trapeze Bracket for Wyr-Grid® 12" (305mm) width. Used to support FiberRunner® 4x4 and 6x4 Channel above or below the Wyr-Grid® 12" Pathway using the same 1/2" or 12mm threaded rod used to support the WGTB12BL bracket. Hardware for attaching to threaded rod sold separately (see page 13). Available in black powder coat only.	1	10
FRTBWG18BL	FiberRunner® QuikLock™ Threaded Rod Trapeze Bracket for Wyr-Grid® 18" (457mm) width. Used to support FiberRunner® 4x4, 6x4, and 12x4 Channel above or below the Wyr-Grid® 18" Pathway using the same 1/2" or 12mm threaded rod used to support the WGTB18BL bracket. Hardware for attaching to threaded rod sold separately (see page 13). Available in black powder coat only.	1	10
FRTBWG24BL	FiberRunner® QuikLock™ Threaded Rod Trapeze Bracket for Wyr-Grid® 24" (610mm) width. Used to support FiberRunner® 4x4, 6x4, and 12x4 Channel above or below the Wyr-Grid® 24" Pathway using the same 1/2" or 12mm threaded rod used to support the WGTB24BL bracket. Hardware for attaching to threaded rod sold separately (see page 13). Available in black powder coat only.	1	10
FRTBWG30BL	FiberRunner® QuikLock™ Threaded Rod Trapeze Bracket for Wyr-Grid® 30" (762mm) width. Used to support FiberRunner® 4x4, 6x4, 12x4, and 24x4 Channel above or below the Wyr-Grid® 30" Pathway using the same 1/2" or 12mm threaded rod used to support the WGTB30BL bracket. Hardware for attaching to threaded rod sold separately (see page 13). Available in black powder coat only.	1	10
WG12FRTBBL	Wyr-Grid® 12" (305mm) width FiberRunner® QuikLock™ Trapeze Bracket. Attaches to the Wyr-Grid® 12" (305mm) wide Pathway to support a secondary FiberRunner® 4x4 or 6x4 Channel above the Wyr-Grid® Pathway. Available in black powder coat only.	1	—
WG18FRTBBL	Wyr-Grid® 18" (457mm) width FiberRunner® QuikLock™ Trapeze Bracket. Attaches to the Wyr-Grid® 18" (457mm) wide Pathway to support a secondary FiberRunner® 4x4 or 6x4 Channel above the Wyr-Grid® Pathway. Available in black powder coat only.	1	—
WG24FRTBBL	Wyr-Grid® 24" (610mm) width FiberRunner® QuikLock™ Trapeze Bracket. Attaches to the Wyr-Grid® 24" (610mm) wide Pathway to support a secondary FiberRunner® 4x4 or 6x4 Channel above the Wyr-Grid® Pathway. Available in black powder coat only.	1	—
WG30FRTBBL	Wyr-Grid® 30" (762mm) width FiberRunner® QuikLock™ Trapeze Bracket. Attaches to the Wyr-Grid® 30" (762mm) wide Pathway to support a secondary FiberRunner® 4x4 or 6x4 channel above the Wyr-Grid® Pathway. Available in black powder coat only.	1	—
<b>Wyr-Grid® Mounting Bracket for Strut</b>			
WGSKBL	Strut mounting clip assembly allows Wyr-Grid® Pathway to be attached directly to standard 1 5/8" wide strut structures. Contains support member, two clips, and all hardware for assembly.	1	5

For electro zinc finish replace BL (Black) with EZ.

## Wyr-Grid® Accessories

- Offered in three different heights: 2" (50mm), 4" (102mm), and 6" (152mm)
- Standard finishes are black powder coat and electro zinc plated



WGSW2BL



WGSW4BL



WGSW6BL



WGINTBRC2BL



WGINTBRC4BL



WGINTBRC6BL



WGHRDWKTBL

Part Number	Part Description	Std. Pkg. Qty.	Std. Ctn. Qty.
<b>Wyr-Grid® Pathway Snap-On Sidewalls</b>			
WGSW2BL	Wyr-Grid® 2" (50mm) high Snap-On Sidewalls can be attached anywhere along the pathway where needed to retain cables.	1	40
WGSW4BL	Wyr-Grid® 4" (102mm) high Snap-On Sidewalls can be attached anywhere along the pathway where needed to retain cables.	1	40
WGSW6BL	Wyr-Grid® 6" (152mm) high Snap-On Sidewalls can be attached anywhere along the pathway where needed to retain cables.	1	40

For electro zinc finish replace BL (Black) with EZ.

### Wyr-Grid® Pathway Intersection Bend Radius Controls

WGINTBRC2BL	Wyr-Grid® 2" (50mm) high Snap-On Intersection Bend Radius Control provides 3" (76mm) bend radius control and can be installed without cutting or fabrication at tees, crosses, and right angle intersections.	1	—
WGINTBRC4BL	Wyr-Grid® 4" (102mm) high Snap-On Intersection Bend Radius Control provides 3" (76mm) bend radius control and can be installed without cutting or fabrication at tees, crosses, and right angle intersections.	1	—
WGINTBRC6BL	Wyr-Grid® 6" (152mm) high Snap-On Intersection Bend Radius Control provides 3" (76mm) bend radius control and can be installed without cutting or fabrication at tees, crosses, and right angle intersections.	1	—

For electro zinc finish replace BL (Black) with EZ.

### Wyr-Grid® Hardware

WGHRDWKTBL	<p>The hardware kit is used when field fabricating a right angle, allowing large radii to be created by cutting the pathway, bending it, and securing it into a right angle.</p> <p>12" (305mm) width requires 6 pieces to create a 15.8" radius                      18" (457mm) width requires 9 pieces to create a 24.4" radius                      24" (610mm) width requires 12 pieces to create a 33.4" radius                      30" (762mm) width requires 15 pieces to create a 41.5" radius</p>	1	10
------------	--	---	----

Available in BL (Black) only.



# StructuredGround™ Grounding System for Wyr-Grid® System

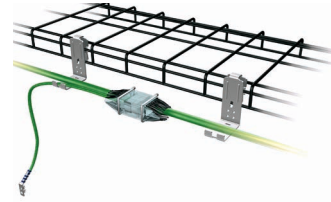
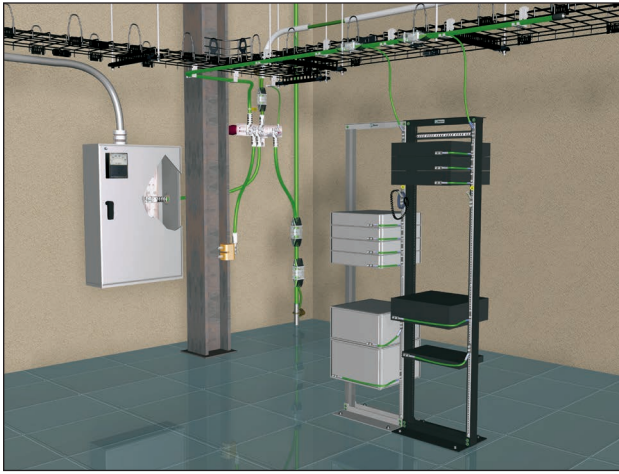

GACB brackets provide a convenient location to attach ground wire for grounding Wyr-Grid® System to the ground bar.

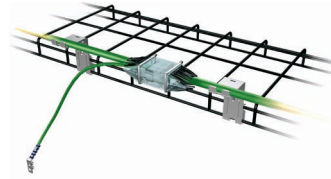

GACB brackets provide the flexibility to install grounding conductors above or below the Wyr-Grid® System.



GACB-2

GACB-3

GACBJ6\*U

Part Number	Part Description	Std. Ctn. Qty.
<b>Grounding Cable Hanger Brackets</b>		
GACB-2	Supports grounding conductors positioned below Wyr-Grid® Pathways and automatically makes bonding connection. Used with ladder rack and wire basket.	1
GACB-3	Supports grounding conductors positioned above Wyr-Grid® Pathways and automatically makes bonding connection. Used with ladder rack and wire basket.	1
GACBJ6*U	6 AWG grounding jumper with 2-hole copper compression connectors. Used to bond Wyr-Grid® to Telecommunications Grounding Busbar (TGB) (only required in one location).	1

\* = Length in inches. Available in 8", 12", and 18" lengths.

## Wyr-Grid® Hardware and Tools



HNLW12

HNLW12M

FR716DR

WGCT-A

WGCT-M

Part Number	Part Description	Std. Pkg. Qty.	Std. Ctn. Qty.
<b>Hardware</b>			
HNLW12	1/2-13 hex nut and 1/2 lock washer for use in attaching trapeze brackets to threaded rod.	100	—
HNLW12M	12mm hex nut and 12mm lock washer for use in attaching trapeze brackets to threaded rod.	100	—
<b>Tools</b>			
FR716DR	7/16" nut driver for use with the FiberRunner®, GridRunner™, and Wyr-Grid® Systems.	1	10
WGCT-A	Battery powered cutting tool for cutting Wyr-Grid® Cable Trays, 2 – 18 volt Lithium-Ion batteries, and 115 volt, 60 Hz charger included.	1	—
CD-WGCD-1	Wyr-Grid® Replacement Cutting Die for the automatic cutting tool.	1	—
WGCT-M	Manual cutting tool for cutting Wyr-Grid® Cable Trays. Weight: 5.4 lbs. (2.45 kg)	1	—

## Wire Fill for Wyr-Grid® Overhead Cable Tray Routing System

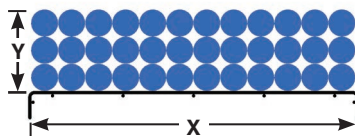

Table 1

X (in.)	Y (in.)	Internal Area (in <sup>2</sup> )	Category 6A (SD) Dia. 0.240" 6.1mm	Category 6A Dia. 0.300" 7.6mm	Category 6 Dia. 0.240" 6.1mm	X (in.)	Y (in.)	Internal Area (in <sup>2</sup> )	Category 6A (SD) Dia. 0.240" 6.1mm	Category 6A Dia. 0.300" 7.6mm	Category 6 Dia. 0.240" 6.1mm
12.2	2	24.3	269	172	269	24.2	2	48.3	534	342	534
	4	48.7	538	344	538		4	96.7	1069	684	1069
	6	73.0	807	516	807		6	145.0	1603	1026	1603
18.2	2	36.3	401	257	401	30.2	2	60.3	666	427	666
	4	72.7	804	514	804		4	120.7	1334	854	1334
	6	109.0	1205	771	1205		6	181.0	2000	1280	2000

"Y" equates to the height of the Wyr-Grid® Optional Sidewalls. The internal area defines the allowable fill capacity based on the Wyr-Grid® Pathway width and optional sidewall height. The Wyr-Grid® Pathway cable fill is based on NEC allowable fill of 50%. The above cable diameters represent the nominal Panduit cable diameter per performance level.

### Load Rating for Wyr-Grid® Pathways

Two different industry standards provide methods by which the load rating of a cable tray system is identified. Those standards are EN 61537:2007 (Cable management – cable tray systems and cable ladder systems) and NEMA VE1/CSA 22.2 (Metal Cable Tray Systems). The EN 61537:2007 standard takes into account various pathway configurations such as Tee Intersections, Cross Intersections, Straight Sections and Straight Sections with Splice Connectors. The NEMA VE1/CSA 22.2 load rating test strictly evaluates the straight sections and does not address any of the directional changes that would need to be fabricated in the field. Furthermore, it does not identify a deflection limit for the loaded pathways. When specifying a cable tray system it is imperative that the system will support the required load in any pathway configuration without excessive deflection. Therefore, the EN 61537:2007 test requirements for load rating are much more representative to what will be encountered in the field.

The Wyr-Grid® Pathway is unique in that the load rating is not dependent on the height of a sidewall. The optional sidewalls on the Wyr-Grid® System are simply intended to retain cables where and when required. They do not contribute to the overall strength of the product. The sidewall height and pathway width on traditional wire basket systems determine its load carrying capacity. These systems require the sidewall to be removed when creating tee intersections and cross intersections, drastically reducing the overall strength of the pathway. The Wyr-Grid® System does not require sidewall removal when creating intersections, therefore the overall strength of the pathway is not compromised.

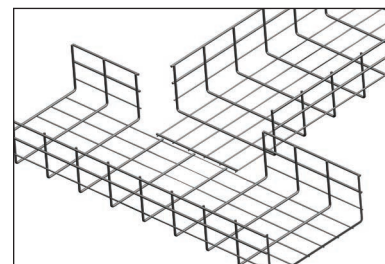

Traditional Wire Basket  
Sidewall Removal Required

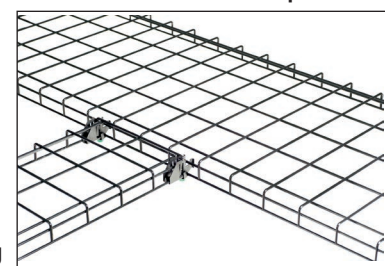

Wyr-Grid® Pathways  
No Sidewall Removal Required

The Wyr-Grid® Pathway System has been engineered and tested to support loads that greatly exceed its cable carrying capacity. Table 2 provides an example of the practical loads that will be encountered when the pathway is filled to its capacity utilizing common data cables\*. Identification of the Wyr-Grid® Overhead Cable Tray Routing System load rating was obtained through testing protocol according to EN 61537:2007. The load rating for the system is identified as the Safe Working Load (SWL) as shown in Table 2. The SWL is an evenly distributed load at which the midspan deflection of the cable tray is less than 1/100th of the span between supports in the longitudinal direction, as shown in Figure 1. Furthermore, the transverse deflection at the SWL must be less than 1/20th of the cable tray width, as shown in Figure 2. The SWL ratings in the table apply for Wyr-Grid® Cable Tray installed in any of the following configurations; cable tray only, straight splice, cross intersections, and tee intersections.

\*In applications where power cables or premise distribution fiber cables are routed on the Wyr-Grid® Pathway, the Safe Working Loads (SWL) also apply.

Table 2

Part Number	Tray Width (In.)	Cable Load (lbs/ft)*			Safe Working Load (lbs/ft)					
		Category 6A (SD)	Category 6A	Category 6	4 Foot Support Span	5 Foot Support Span	6 Foot Support Span	7 Foot Support Span	8 Foot Support Span	9 Foot Support Span
WG12BL10	12	24.21	18.06	25.02	113	90	69	54	43	34
WG18BL10	18	36.15	26.99	37.36	115	90	67	52	41	31
WG24BL10	24	48.09	35.91	49.69	116	92	69	54	53	33
WG30BL10	30	60.00	44.80	62.00	116	92	69	54	53	33

\*The cable load is defined by the maximum wire fill, as shown in Table #1 for each pathway width and 6" depth. For electro zinc finish replace BL (Black) with EZ.



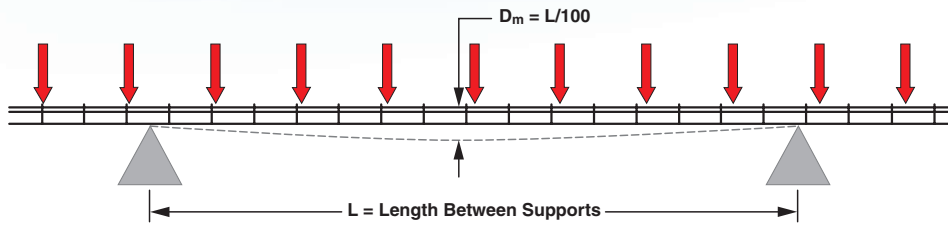

Figure 1. Midspan Deflection Schematic of Cable Tray, Side View

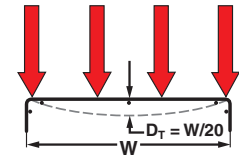

Figure 2. Transverse Deflection Schematic of Cable Tray, End View

## Standards Compliance

<p><b>UL Underwriters Laboratories, Inc.</b> Underwriters Laboratories, Inc. is an independent, not-for profit safety testing and certification organization based in the United States.</p>	<p>UL Classified as an Equipment Grounding Conductor Classification to this standard provides a 100 maximum fuse ampere rating, circuit breaker ampere trip setting, or circuit breaker protective relay ampere trip setting for ground-fault protection of any cable circuit within the cable tray system.</p> <p>This system provides a bolted mechanical bond between system components eliminating the need for bonding jumpers between pathway sections.</p>
<p><b>NEMA National Electrical Manufacturers Association</b> NEMA provides a forum for the standardization of electrical equipment, enabling consumers to select from a range of safe, effective, and compatible electrical products.</p>	<p>NEMA VE1/CSA 22.2 (Metal Cable Tray Systems) Certification to this standard ensures that electrical continuity exists between pathway sections when joined together with the splice connectors complying with the electrical resistance requirements of the standard. Furthermore, the load rating has been identified ensuring the pathway sections will not fail when utilized for its intended application.</p>
<p><b>CSA Canadian Standards Association</b> Canadian Standards Association is a not-for-profit membership based association serving business, industry, government, and consumers in Canada and the global marketplace. CSA works in Canada and around the world to develop standards that enhance public safety and health.</p>	
<p><b>International Electrotechnical Commission*</b> The IEC is the world's leading organization that prepares and publishes International Standards for all electrical, electronic and related technologies – collectively known as “electrotechnology”.</p>	<p>EN 61537:2007 Cable management. Cable tray systems and cable ladder systems.</p>
<p><b>RoHS</b></p>	<p>All Wyr-Grid® Overhead Cable Tray Routing System components are RoHS compliant.</p>

\*Compliance for CE Marking (European Conformity) is under evaluation.

## Wyr-Grid® Design Tools

The Wyr-Grid® Overhead Cable Tray Routing System is offered with two different Design Tools that allow accurate system drawings to be created which speeds overall system design, specification and implementation. Both VISIO<sup>†</sup> and AutoCAD<sup>\*\*</sup> versions are available as free downloads from: [www.panduit.com/products/selectiontools](http://www.panduit.com/products/selectiontools).

### Wyr-Grid® Design Tool for AutoCAD<sup>\*\*</sup> includes:

- Drag-and-Drop Functionality
- Ability to design in 2D or 3D
- Versions Compatible with AutoCAD<sup>\*\*</sup> and AutoCAD<sup>\*\*</sup> LT
- Automated BOM Generator

### Data Center VISIO<sup>†</sup> Layout Tool includes:

- Drag-and-Drop Functionality
- Ability to design in 2D (stencils for three different views are provided)
- Automated BOM Generator

<sup>†</sup>VISIO is a registered trademark of Microsoft Corporation in the United States and/or other countries.

<sup>\*\*</sup>AutoCAD is a registered trademark of Autodesk, Inc.

## Real-World Solutions

*With a proven reputation for excellence and innovation, Panduit and our partners work with you to overcome challenges and implement real-world solutions that create a competitive business advantage. Panduit offers the broadest range of solutions, from data centers and intelligent buildings to manufacturing operations, to help you build a **smarter, unified business foundation**.*



### Technology Leadership

Panduit develops innovative physical infrastructure solutions that meet the rapidly changing needs of our clients, from hardware and software to advisory services. This commitment is supported by investment in advanced research, solutions-focused product development, world-class manufacturing, and collaboration with customers at the forefront of technology.



### Partner Ecosystem

Our best-in-class partner ecosystem offers a comprehensive portfolio of services that span the project lifecycle, from planning and design to delivery, deployment, maintenance, and operation. Panduit business partners – distributors, and certified architects, consultants, engineers, designers, system integrators, and contractors – are qualified to help you achieve your objectives and realize predictable and measurable results.



### Strategic Alliances

Panduit cultivates long-term strategic alliances with industry leaders, including Cisco Systems, EMC, IBM, and Rockwell Automation, to develop, optimize, and validate solutions for our customers. This investment in people and resources helps solve our customers' greatest business challenges.



### Global Business Commitment

Panduit is committed to delivering a consistently high level of quality and service the world over. With a presence in more than 100 countries, local Panduit sales representatives and technical specialists offer guidance and support that bring value to your business. Our global supply chain, which includes manufacturing, customer service, logistics, and distribution partners, provides prompt response to your inquiries and streamlines delivery to any worldwide destination.



### Sustainability

With a commitment to environmental sustainability, Panduit develops and implements solutions that protect, replenish, and restore the world in which we live. This commitment is demonstrated by Panduit's LEED Gold certified World Headquarters, leveraging the Unified Physical Infrastructure<sup>SM</sup> approach to enable convergence of critical building systems to drive energy efficiency and ongoing operational improvement.

Panduit Corp.  
World Headquarters  
Tinley Park, IL 60487

cs@panduit.com  
US and Canada: 800.777.3300  
Europe, Middle East, and Africa:  
44.20.8601.7200  
Latin America: 52.33.3777.6000  
Asia Pacific: 65.6305.7575

[www.panduit.com](http://www.panduit.com)

**PANDUIT**<sup>®</sup>